

# Water Heater



**Thermo Top Evo Parking Heater** e1 00 0258

## Installation documentation

### Dacia Duster

Diesel  
from Model Year 2011  
Left-hand drive vehicle  
Manual air conditioning  
2WD / 4WD  
5- / 6-gear manual transmission



#### **WARNING!**

Hazard warning:

Incorrect installation or repair of Webasto heating systems may cause a fire or result in the emission of carbon monoxide, which can be fatal. Serious or fatal injuries can be caused as a result.



Specialist company training, technical documentation, specialised tools and equipment are required to install and repair Webasto heating and cooling systems. Only original Webasto parts must be used. For this, also see the catalog of air and water heater accessories from Webasto.

**NEVER attempt to install or repair Webasto heating or cooling systems if you have not successfully completed the company training and thereby acquired the required technical skills, or if you do not have access to the required technical documentation, tools and equipment needed to carry out correct installation and repairs.**

ALWAYS follow all Webasto installation and repair instructions and observe all warnings.

**The initial startup is to be executed with the Webasto Thermo Test Diagnosis.**

Webasto does not accept any liability for defects and damage that are attributable to installation by untrained staff.

**Table of Contents**

Validity	2	Preparing bracket	11
Heater / Installation Kit	3	Preparing installation location	11
Foreword	3	Premounting circulating pump	12
General Instructions	3	Preparing heater	13
Special Tools	3	Installing heater	14
Explanatory Notes on Document	4	Exhaust gas	16
Preliminary Work	5	Fuel	19
Heater installation location	5	Combustion air	22
Preparing electrical system	6	Coolant circuit	23
Electrical system	7	Expansion tank	25
Fan control	8	Final Work	28
Digital timer	10	Operating Instructions for End Customer	29
Remote option (Telestart)	10		

**Validity**

Manufacturer	Model	Type	EG-BE No./ABE
Dacia	Duster	SD	e2 * 2001 / 116 * 0314 * ...

Engine type	Engine model	Output in kW	Displacement in cm <sup>3</sup>
K9K	Diesel	66	1461
K9K	Diesel	79	1461
K9K	Diesel	81	1461

Vehicle and engine types, equipment variants and national specifications not listed in this installation documentation have not been tested. However, installation according to this installation documentation may be possible.

The installation location of the digital timer must be coordinated with the end customer before installation.

**Heater / Installation Kit**

Quantity	Description	Order No.:
1	Basic delivery scope <i>Thermo Top Evo</i>	See price list
1	Installation kit Dacia Duster 2011 Diesel	1316906A
1	Heater control	See price list

**Foreword**

This installation documentation applies to vehicles Dacia Duster Diesel - for validity, see page 2 - from model year 2011 and later, assuming technical modifications to the vehicle do not affect installation, any liability claims excluded. Depending on the vehicle version and equipment, modifications may be necessary during installation with respect to this installation documentation.

The specification of this "installation documentation"; the "operating instructions" and the "installation instructions" of the *Thermo Top Evo* are to be observed under all circumstances.

The corresponding rules of technology and any information from the vehicle manufacturer should be observed during the installation work.

**General Instructions**

Installation should be carried out according to the general, standard rules of technology. Unless specified otherwise, fasten hoses, lines and wiring harnesses to original vehicle lines and wiring harnesses using cable ties. Insulate loose wires and tie back.

Sharp edges should be fitted with rub protection (split-open plastic hose).

Spray unfinished body areas, e.g. drilled holes, with anti-corrosion wax (Tectyl 100K, Order No. 111329).

When installing an IPCU, check or adjust the corresponding settings before the installation.

**Special Tools**

- Torque wrench for 2.0 - 10 Nm
- Hose clamping pliers
- Metric thread-setter kit

**Explanatory Notes on Document**

To provide you with a quick overview of the individual working steps, you will find an identification mark on the outside top right corner of the page in question.

**Mechanical system**

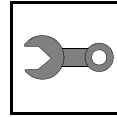

**Electrical system**

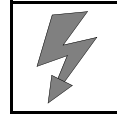

**Coolant circuit**

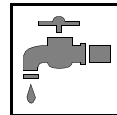

**Fuel**

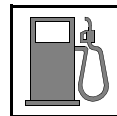

**Exhaust gas**

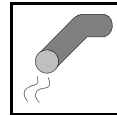

**Combustion air**

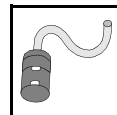

**Software**

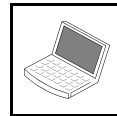

Special features are highlighted using the following symbols:



Specific risk of injury or fatal accidents.



Specific risk of damage to components.



Specific risk of fire or explosion.



Reference to general installation instructions of Webasto components or to the manufacturer's vehicle-specific documents.



Reference to a special technical feature.

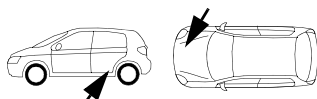

The arrow in the vehicle icon indicates the position on the vehicle and the viewing angle.

**All dimensions are in mm!**

**Tightening torque of 5x13 heater bolts = 8Nm!**

**Tightening torque of 5x15 bolt of water connection piece retaining plate = 7Nm!**

**Preliminary Work**

**WARNING!**

- Open fuel tank cap, ventilate tank.
- Close the fuel tank cap again.
- Disconnect the battery "earth" or "ground" connection.
- Depressurize the cooling system.
- Copy the factory number from the original type label to the duplicate type label.
- Remove years that do not apply from the duplicate label.
- Attach the duplicate label (type label) in the appropriate place.
- Unclamp and remove battery
- Drain coolant fluid
- Remove expansion tank
- Remove coolant reservoir cap
- Remove front underride protection
- Remove rear underride protection at the right
- Remove instrument panel trim on driver's side
- Remove the fan controls

Remove page 29 "Operating Instructions for End Customer" and add to the vehicle operating instructions.



**Heater installation location**

1 Heater

**Installation location**

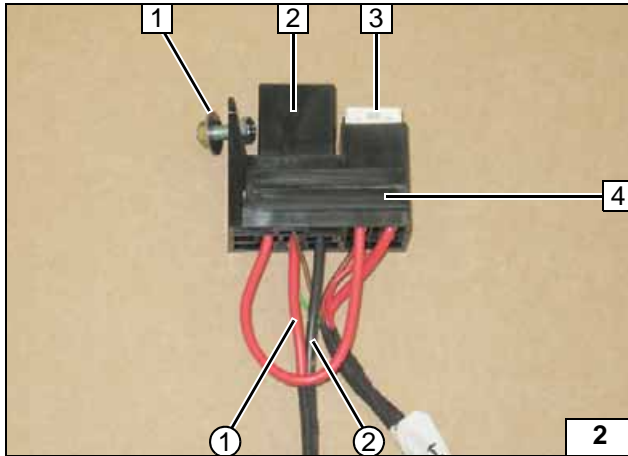

### Preparing electrical system

Make connections according to the following figure.

Wire sections retain their numbering through the entire document.

Insert red (rt) wire ① 4<sup>2</sup> in socket of K1/87a and black (sw) wire ② in the socket of K1/30.

- 1 Premount M5x16 bolt, large diameter washer [2x], nut loosely
- 2 Insert K1 relay
- 3 Insert fuse F4 25A
- 4 Fuse holder of passenger compartment

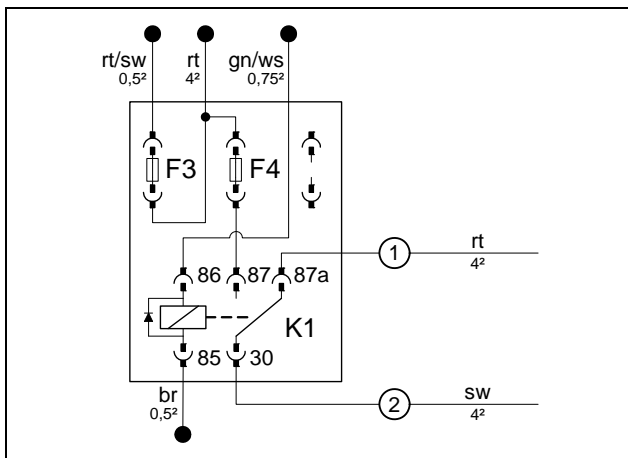

**Premounting fuse holder of passenger compartment**

**Premounting fuse holder of passenger compartment**



**Electrical system**



**Earth wire**

1 Earth wire at original vehicle earth support point

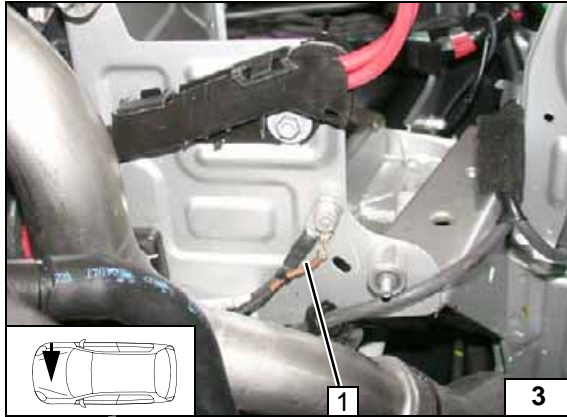

**Positive wire**

1 Positive wire at positive terminal of battery

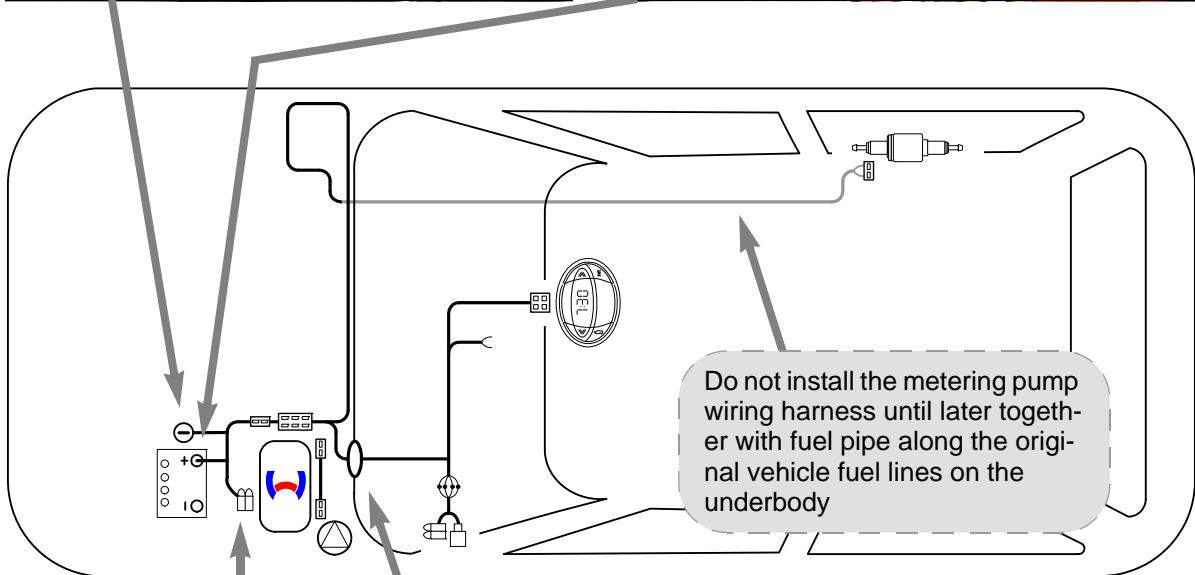

Wiring harness routing diagram

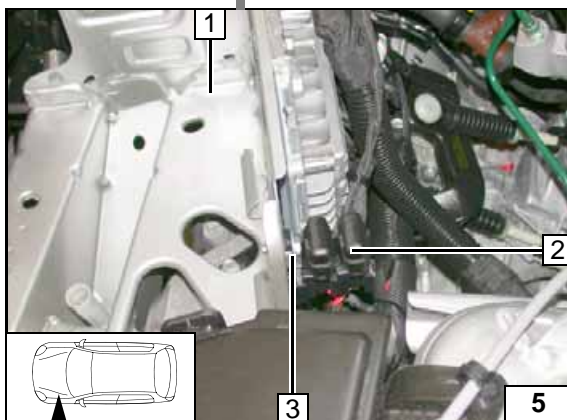

**Fuse holder of engine compartment**

- 1 Battery carrier
- 2 Fuses F1-2
- 3 M5x16 bolt, washer [2x], retaining plate of fuse holder, nut, existing hole

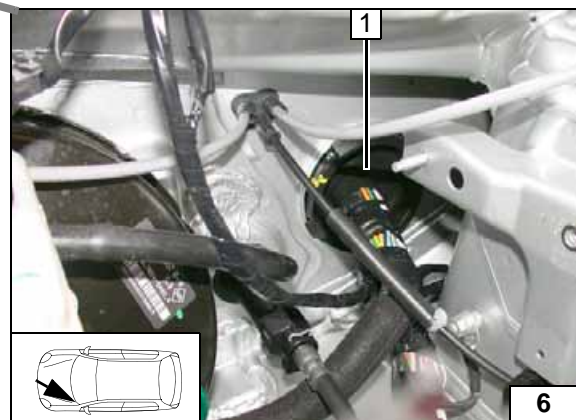

**Wiring harness pass through**

- 1 Protective rubber plug



Fan control

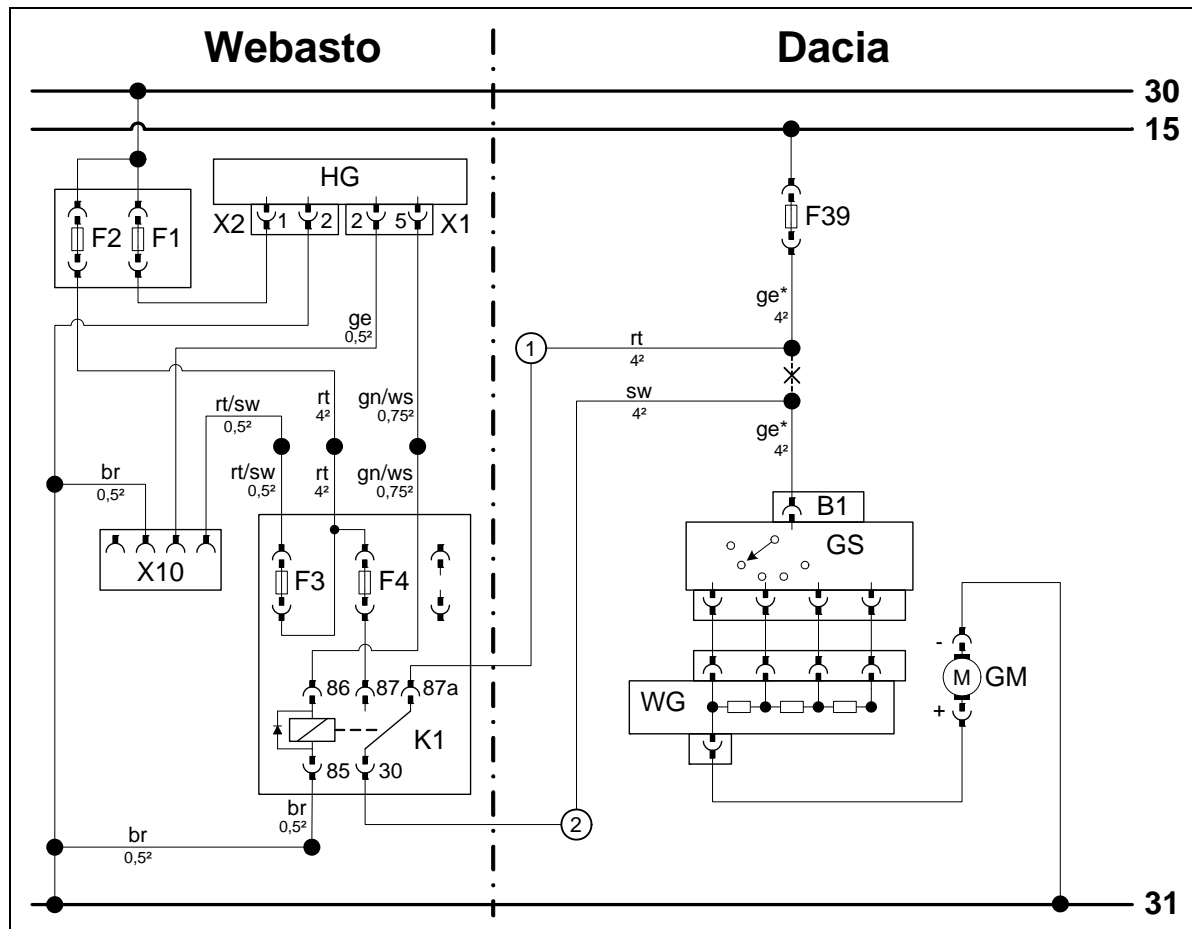

Wiring diagram

Webasto components		Vehicle components		Colours and symbols	
HG	Heater TT-Evo	GM	Fan motor	rt	red
X1	6-pin heater connector	GS	Fan switch	sw	black
X2	2-pin heater connector	WG	Resistor group	ge	yellow
X10	4-pin connector Heater control	B1	Connector B Pin 1	gn	green
K1	Fan relay	F39	30A fuse	br	brown
F1	20A fuse			ws	white
F2	30A fuse			br	brown
F3	1A fuse				
F4	25A fuse				
				X	Cutting point
					Wiring colours may vary.

Legend



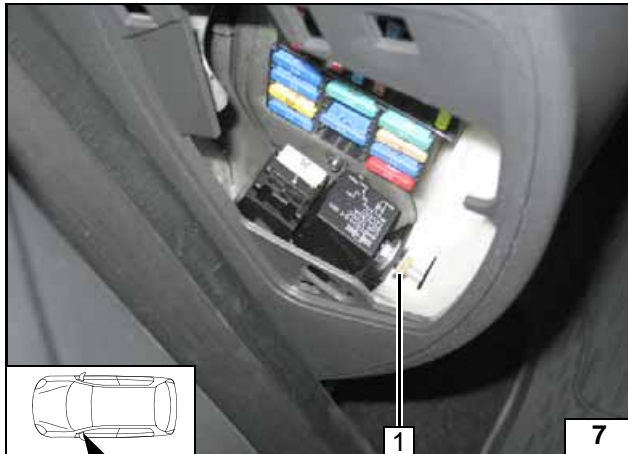

Insert fuse holder of passenger compartment into the recess, tighten bolt 1.



**Mounting fuse holder of passenger compartment**

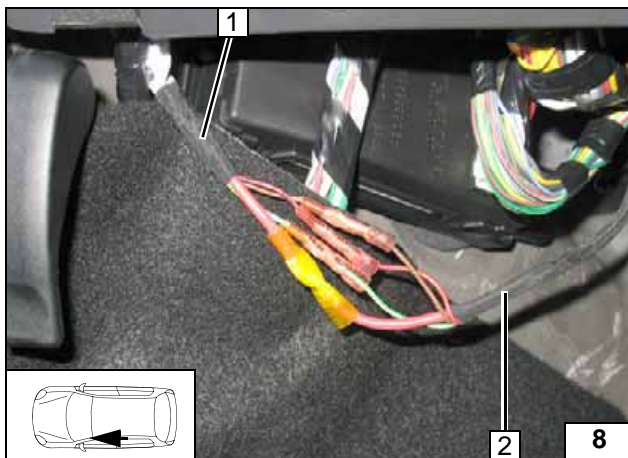

Connect same colour wires of the wiring harness of the passenger compartment fuse holder 1 to those of the heater wiring harness 2 as shown in wiring diagram.



**Connecting wiring harnesses**

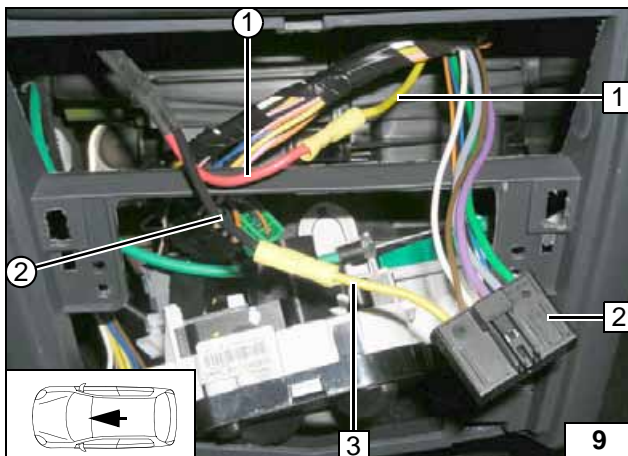

Connection to 6-pin connector B 2 from fan switch.  
Produce connections as shown in wiring diagram.



**Connecting fan-motor**

- 1 Yellow (ge) wire from fuse 39
- 3 Yellow (ge) wire from connector B1
- ① Black (sw) wire from K1/30
- ② Red (rt) wire from K1/87a

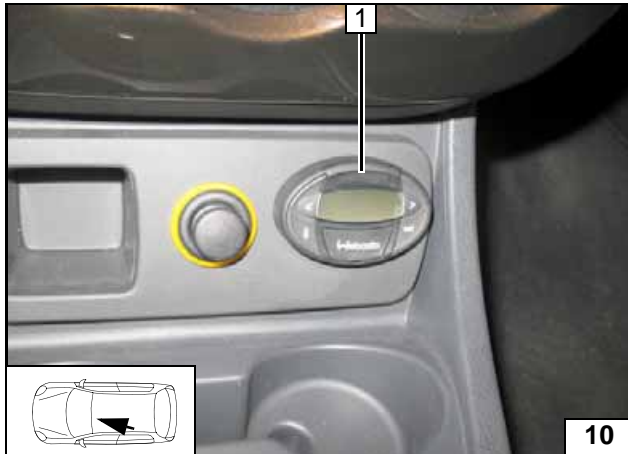

**Digital timer**

1 Digital timer



**Installing digital timer**



**Remote option (Telestart)**

- 1 Telestart bracket
- 2 Telestart
- 3 Original vehicle bolt



**Installing receiver**

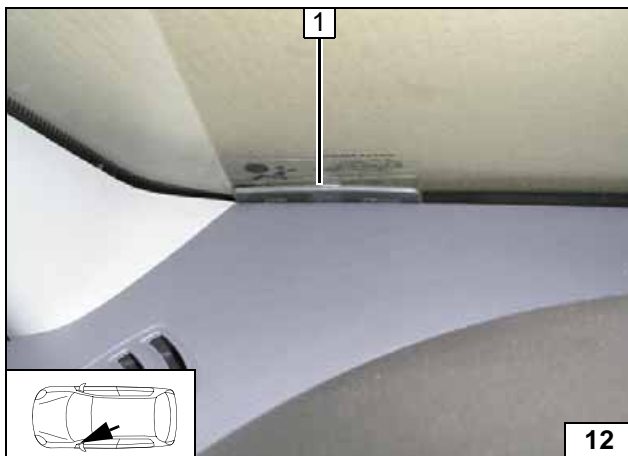

1 Antenna

**Installing antenna**

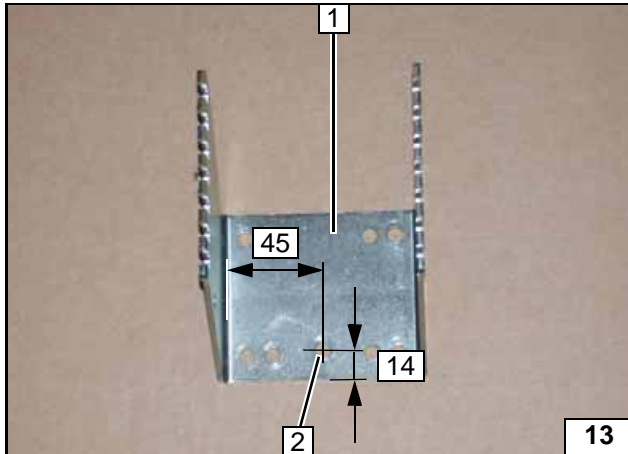
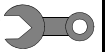

**Preparing bracket**

- 1 Bracket
- 2 7mm dia. hole

Preparing bracket

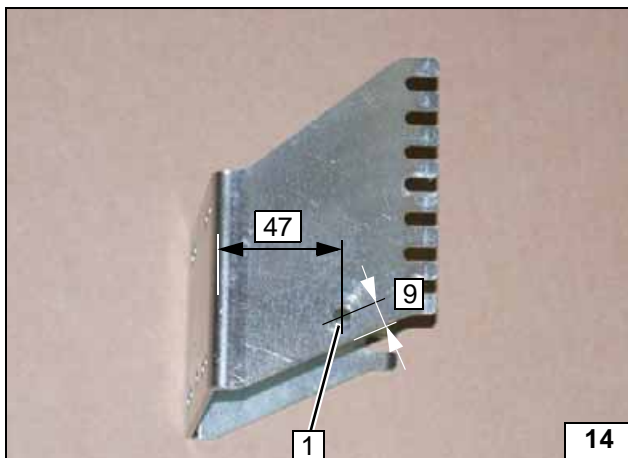

- 1 7mm dia. hole

Preparing bracket

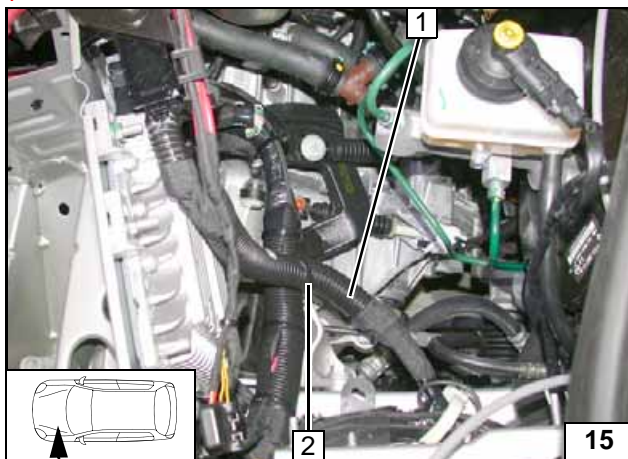

**Preparing installation location**

- 1 Original vehicle wiring harness
- 2 Cable tie

Mounting original vehicle wiring harness

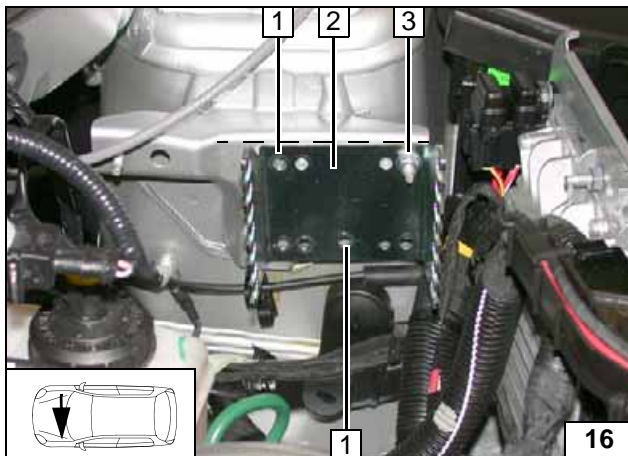

Mount bracket 2 loosely and align to upper edge.

- 1 Copy hole pattern [2x].
- 3 Original vehicle stud bolt, flanged nut

Copying hole pattern

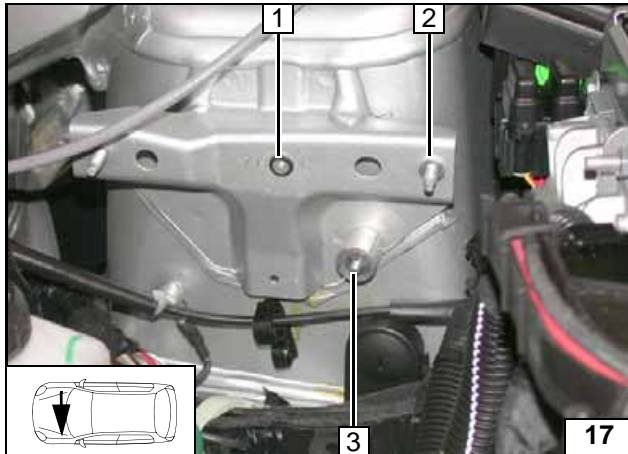
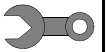

Remove bracket.

- 1 9.1mm dia. hole, rivet nut
- 2 Washer = 11.6mm dia.; original vehicle stud bolt
- 3 M6x35 bolt (insert from wheel well), large diameter washer, 20mm shim, pin lock



Installing rivet nut

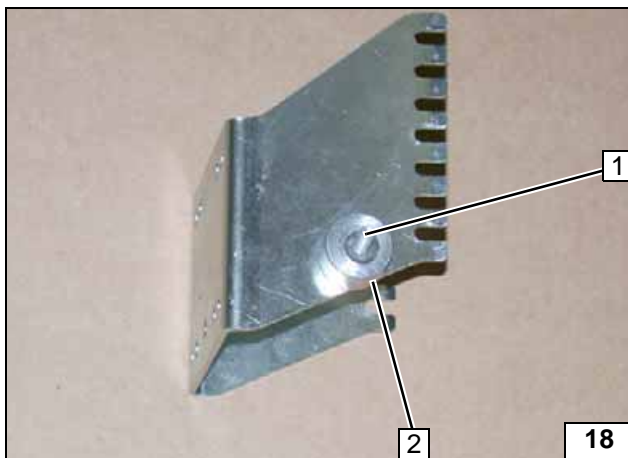

**Premounting circulating pump**

- 1 M6x35 bolt, pin lock
- 2 15mm shim

Preparing bracket

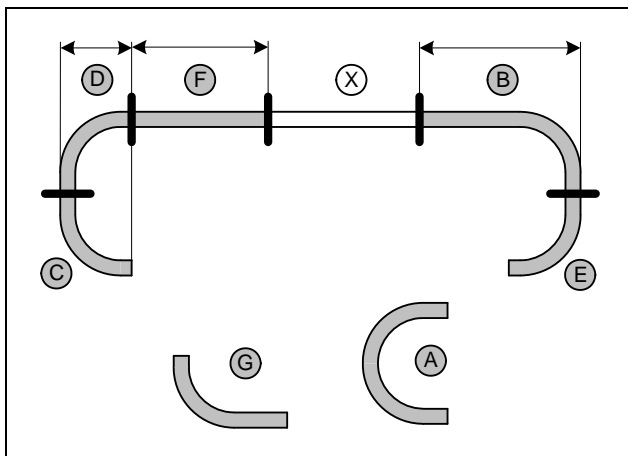

Discard section X

Hose A = 180°, 18mm dia. moulded hose  
Hose G = 90°, 20mm dia. moulded hose

- B = 470
- F = 430



Cutting hoses to length

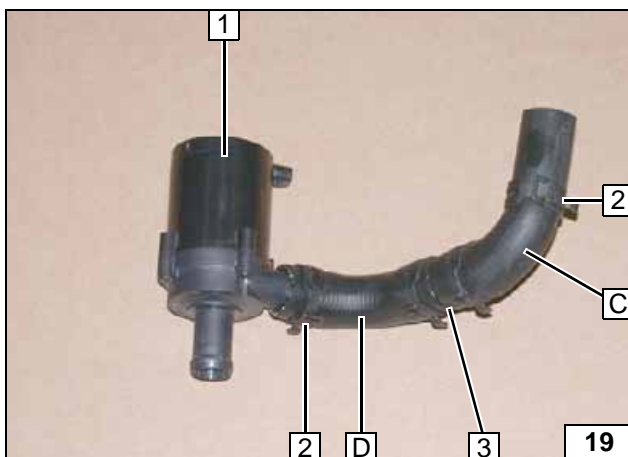

- 1 Circulating pump
- 2 25mm dia. spring clip [2x]
- 3 18x18mm connecting pipe, 25mm dia. spring clip [2x]

Premounting circulating pump



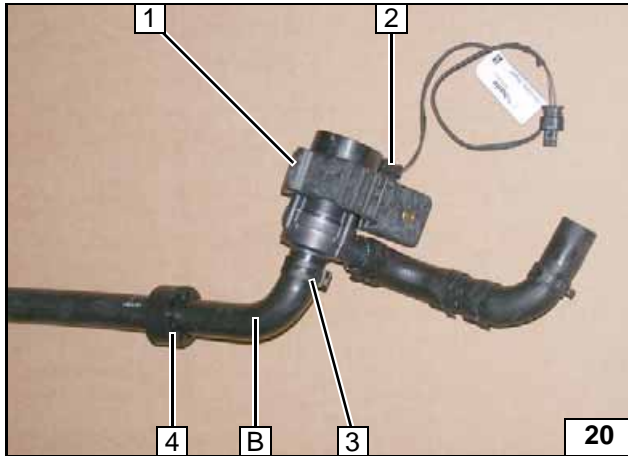
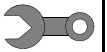

- 1 Circulating pump mounting
- 2 Mount wiring harness of circulating pump
- 3 25mm dia. spring clip
- 4 Slide on black (sw) rubber isolator

Premounting circulating pump

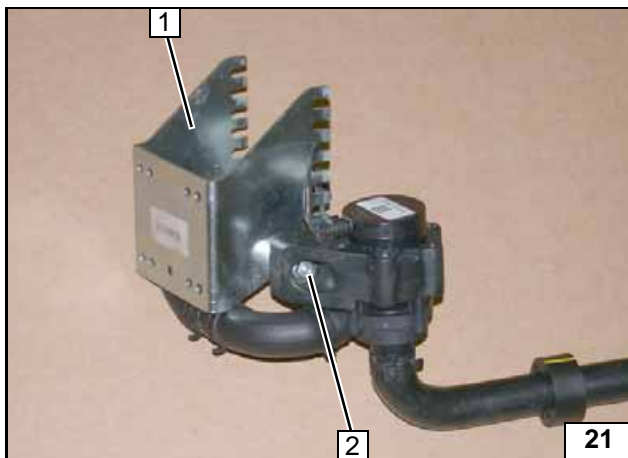

- 1 Bracket
- 2 Washer = 11.7mm dia.; flanged nut

Installing circulating pump

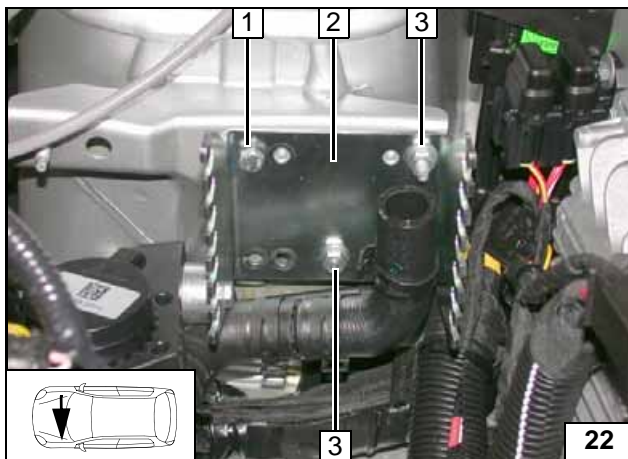

- 1 M6x20 bolt, spring lockwasher
- 2 Bracket
- 3 Flanged nut [2x]

Installing bracket

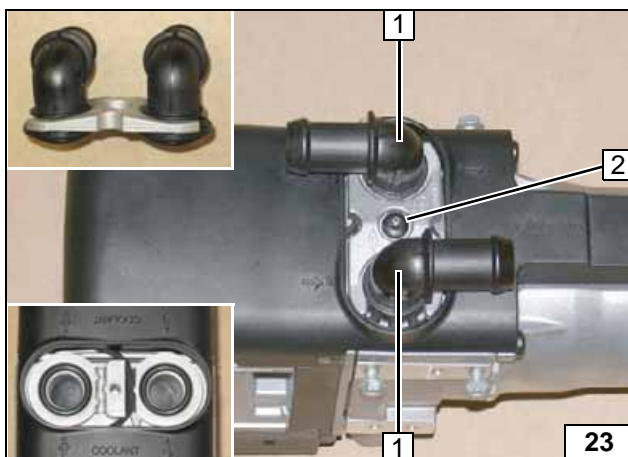

**Preparing heater**

- 1 Coolant connection piece, sealing ring [2x each]
- 2 5x15 mm self-tapping bolt, retaining plate of coolant connection piece



Installing coolant connection pieces

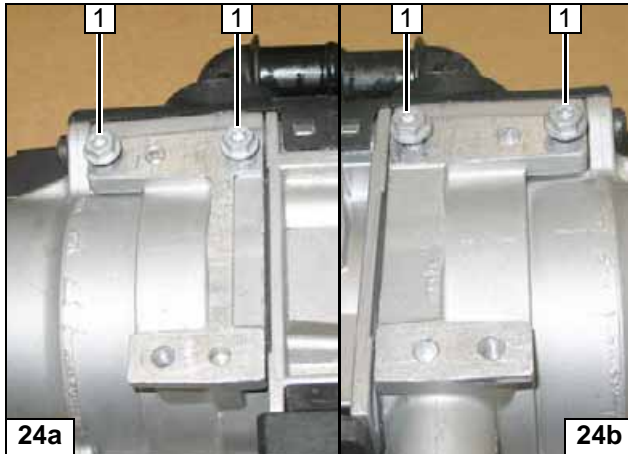
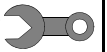

Tap thread with 5x13 self-tapping bolts 1 [4x] and mount loosely (max. 3 thread turns).



Premounting bolts loosely

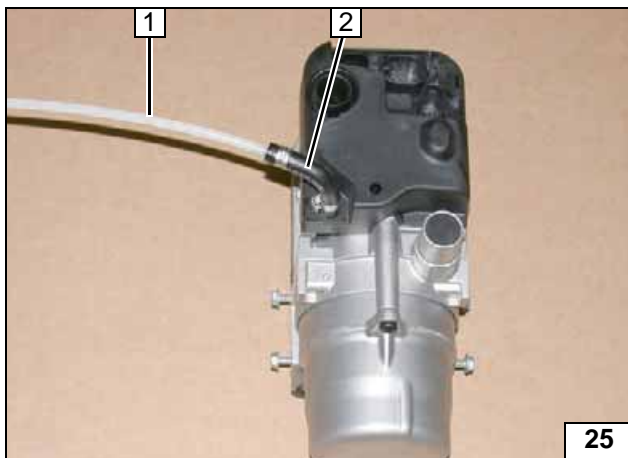

1 Fuel line  
2 Hose section, 10 mm dia. clamp [2x]

Premounting fuel lines

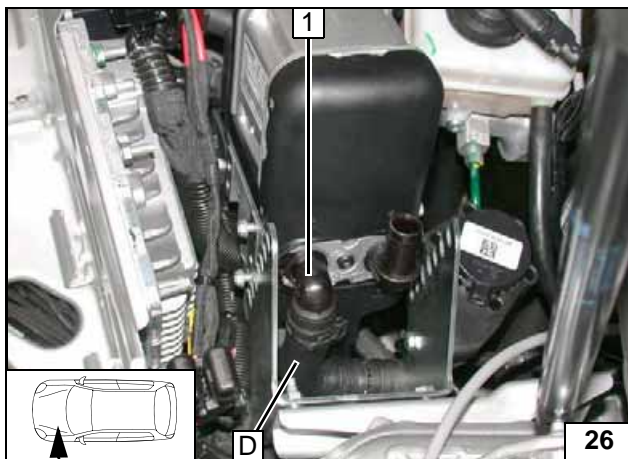

**Installing heater**

1 Connection pieces of heater inlet

Connecting heater inlet

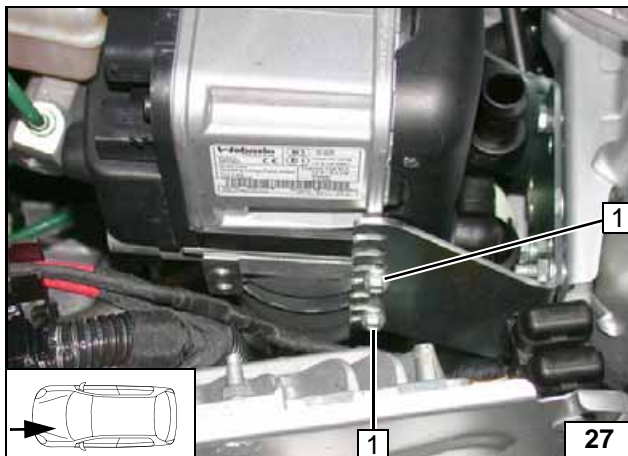

1 Tighten 5x13 self-tapping screws [2x]

Installing heater

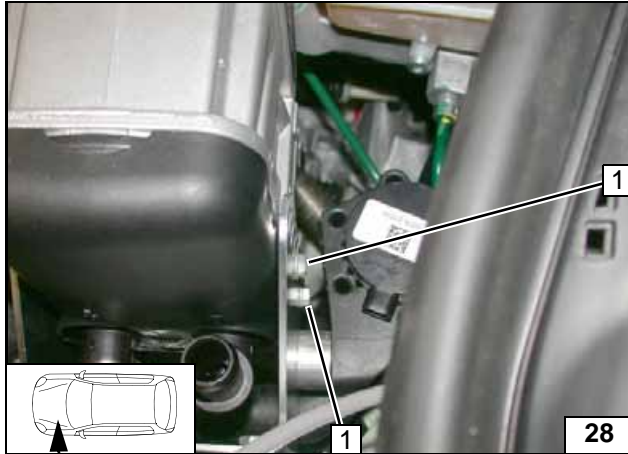
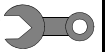

1 Tighten 5x13 self-tapping screws [2x]

Installing heater

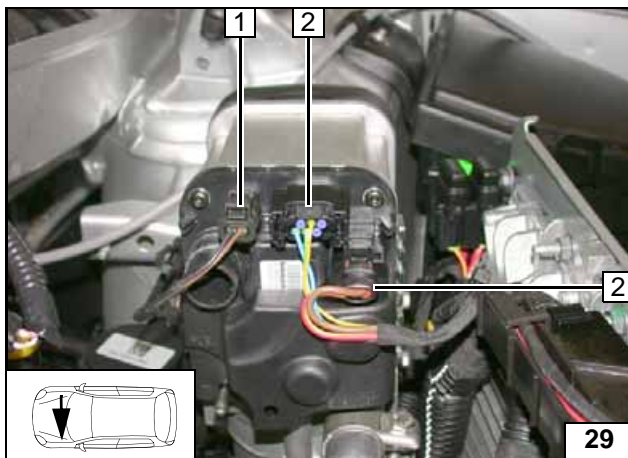

1 Wiring harness of circulating pump  
2 Wiring harness of heater [2x]

Mounting wiring harnesses

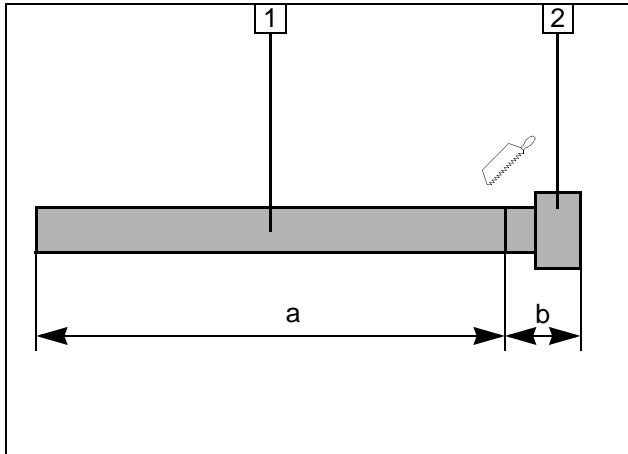
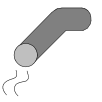

**Exhaust gas**

- 1 Exhaust pipe  
a = 930
- 2 Exhaust end section  
b = 70

Preparing exhaust pipe

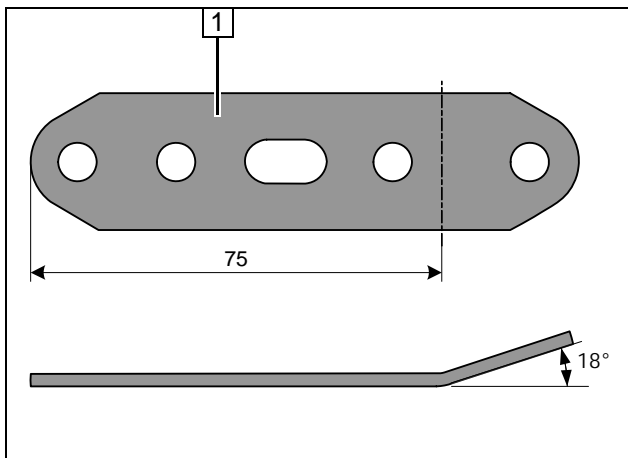

- 1 Perforated bracket

Angling down perforated bracket

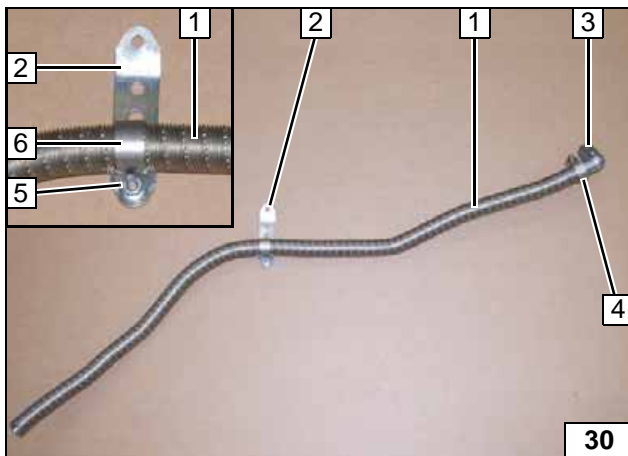

- 1 Exhaust pipe
- 2 Perforated bracket
- 3 Exhaust manifold
- 4 Hose clamp
- 5 Mount M6x20 bolt, flanged nut loosely
- 6 P-clamp

Preparing exhaust pipe

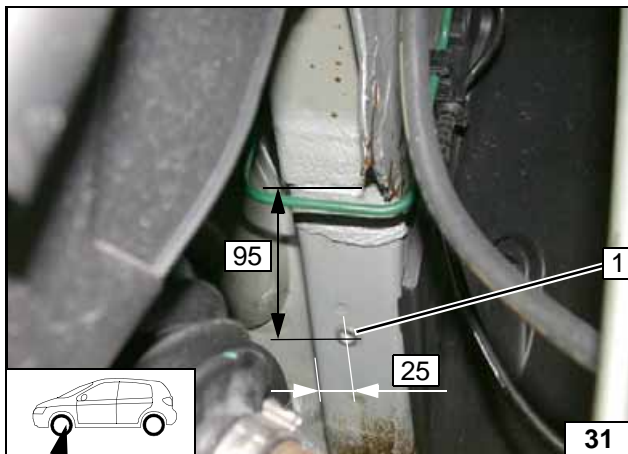

- 1 9.1mm dia. hole, rivet nut

Installing rivet nut



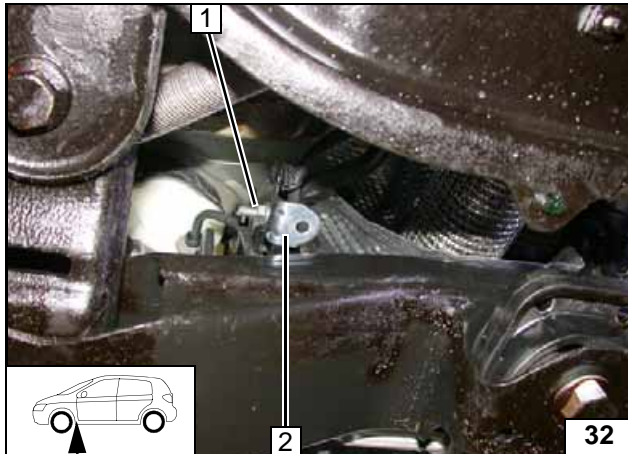

- 1 M6x20 bolt, flanged nut, existing hole
- 2 Angle bracket

Installing angle bracket

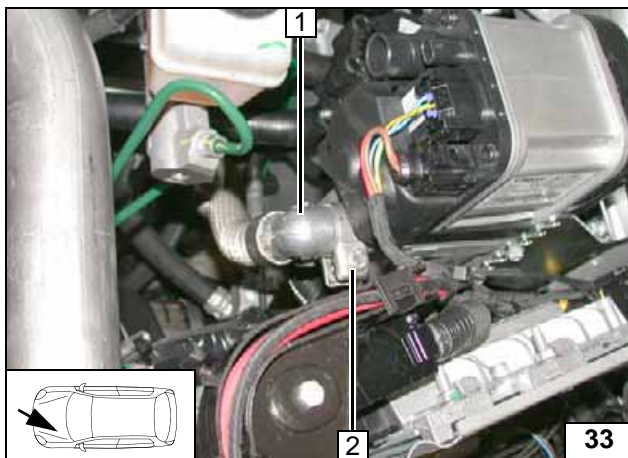

- 1 Exhaust manifold
- 2 Hose clamp

Mounting exhaust pipe

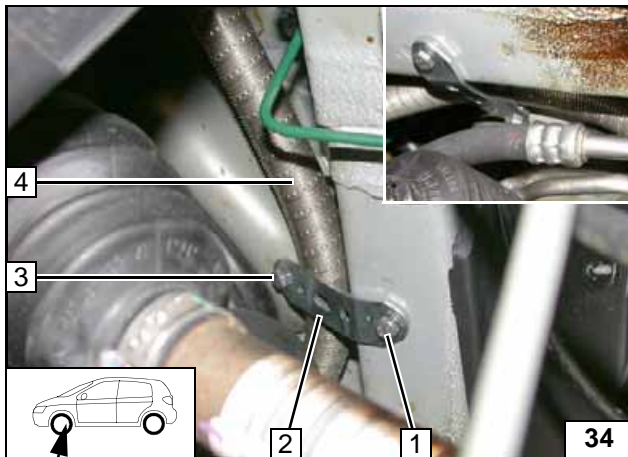

Ensure sufficient distance from neighbouring components.



- 1 M6x20 bolt, spring lockwasher
- 2 Perforated bracket
- 3 Tighten bolt
- 3 Exhaust pipe

Mounting exhaust pipe

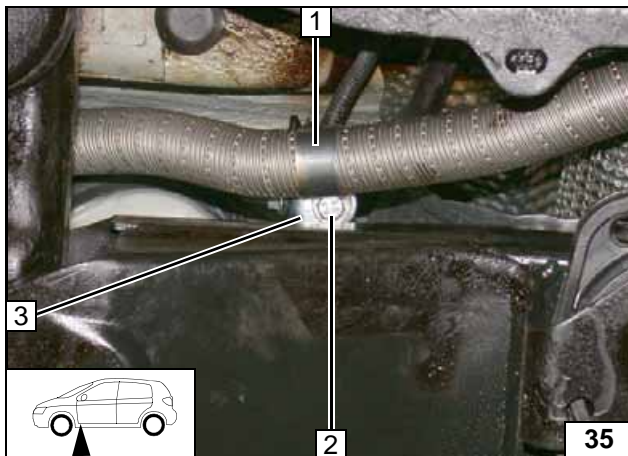

- 1 P-clamp
- 2 M6x20 bolt, flanged nut
- 3 Angle bracket

Mounting exhaust pipe

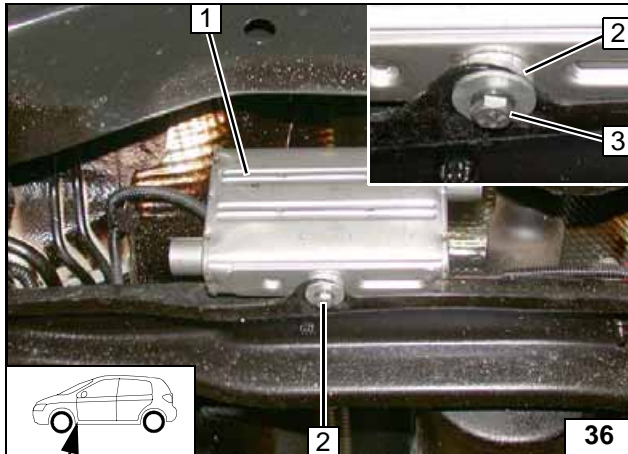

- 1 Silencer
- 2 5mm shim
- 3 M6x20 bolt, spring lockwasher, large diameter washer, 5mm shim, existing hole

**Installing silencer**

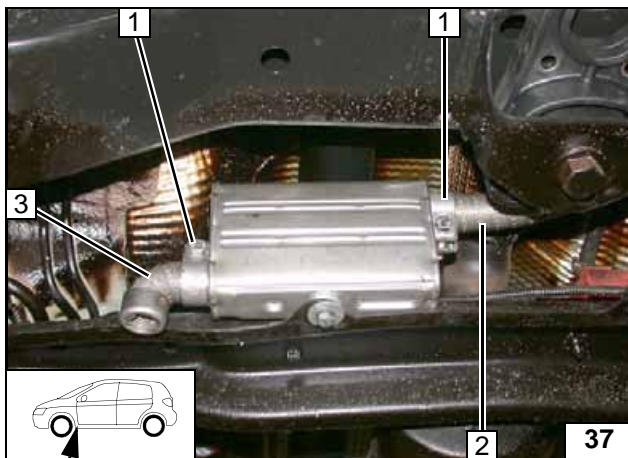

- 1 Hose clamp [2x]
- 2 Exhaust pipe
- 3 Exhaust end section

**Mounting exhaust pipe and end section**

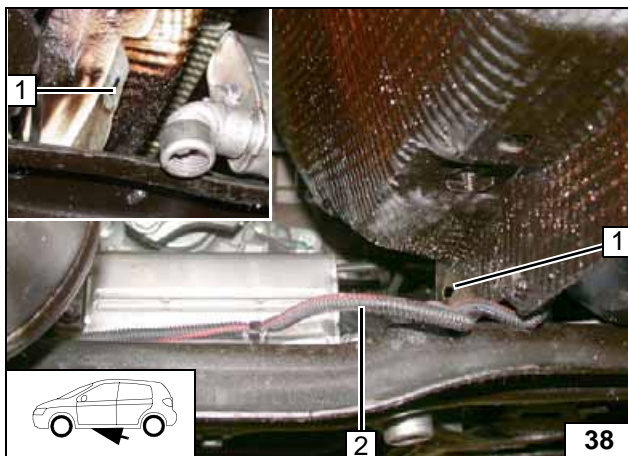

Detach original vehicle wiring harness **2** at position **1** and tie back with cable tie. Ensure sufficient distance from neighbouring components.



**Tying back wiring harness**



**Fuel**

**CAUTION!**

Open the vehicle's fuel tank cap, ventilate the tank and then re-close the tank lock.

Catch any fuel running off in an appropriate container.

Install fuel line and metering pump wiring harness so that they are protected against stone impact. Unless specified otherwise, always fasten using cable ties. Mount the fuel line and wiring harness with rub protection on sharp edges.

**WARNING!**

The fuel line and wiring harness are routed to the metering pump as shown in the wiring harness routing diagram.

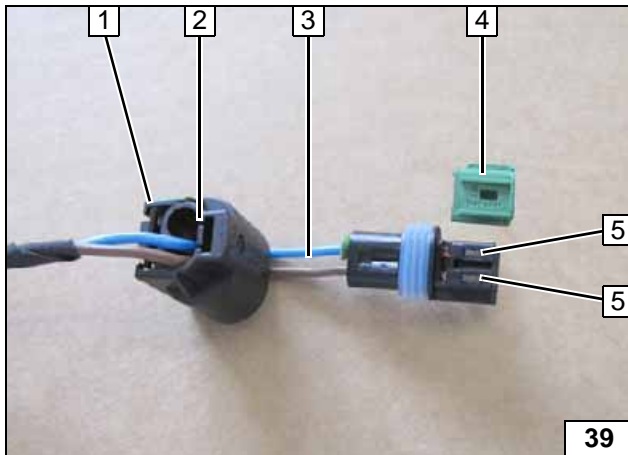

Complete connector of metering pump again after routing. Pin assignment is not relevant.

- 1 Connector housing
- 2 Lock
- 3 Blue/brown (bl/br) wires
- 4 Coding
- 5 Time lock



**Dismantling connector**

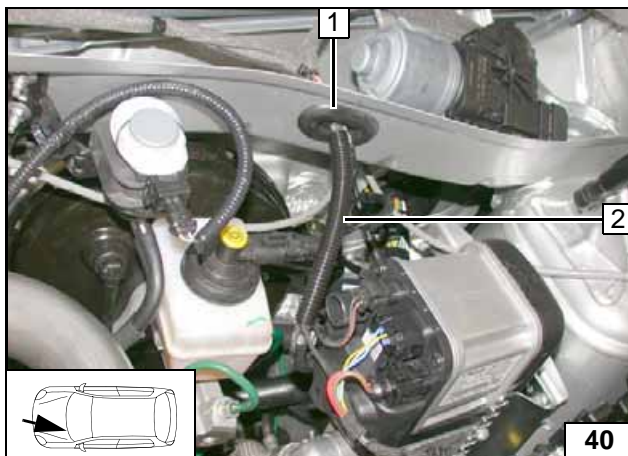

Route fuel line and wiring harness of metering pump in corrugated tube 2 to the coolant reservoir.

- 1 Protective rubber plug



**Installing lines**

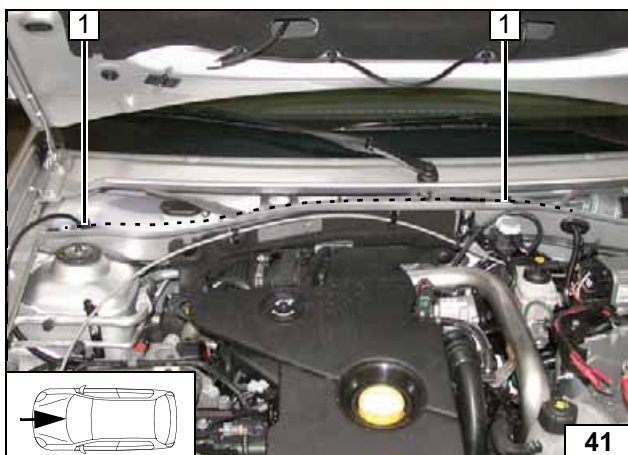

Route fuel line and wiring harness of metering pump to coolant reservoir on the right vehicle side.

- 1 Fuel line, metering pump wiring harness



**Installing lines**



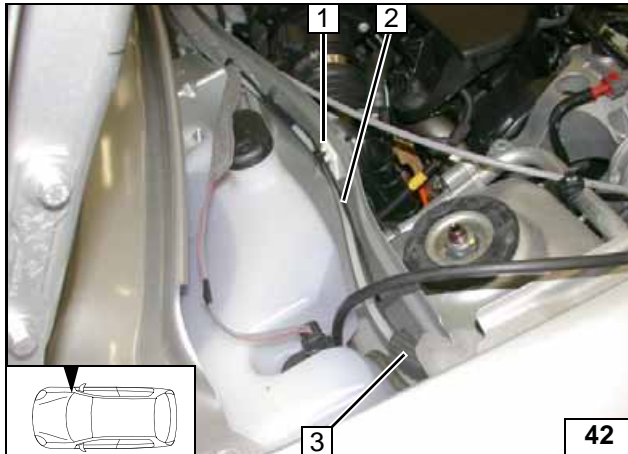

Slide on fabric protective hose 3 on fuel line and wiring harness of metering pump 2 and position in original vehicle pass through.

- 1 Remove adhesive surface, adhesive base, cable tie

Installing lines



- 1 Fuel line, metering pump wiring harness in corrugated tube

Installing lines

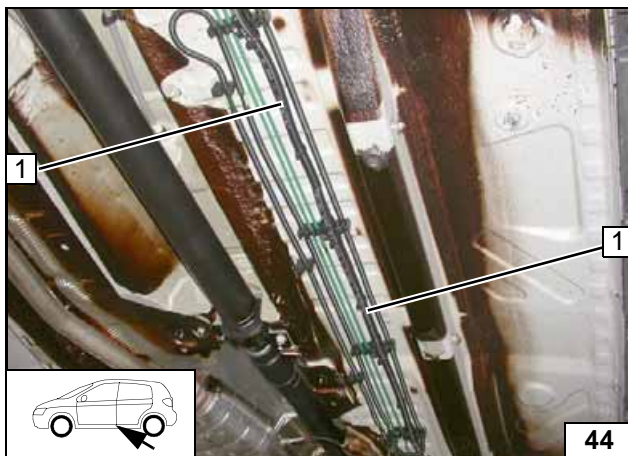

- 1 Fuel line, metering pump wiring harness in corrugated tube

Installing lines

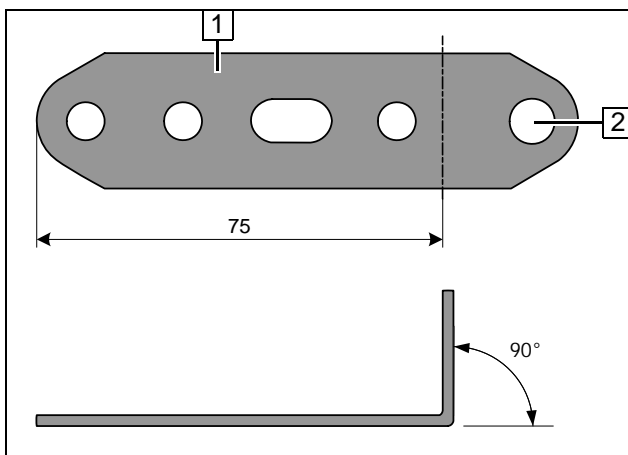

- 1 Perforated bracket
- 2 8.5mm dia. hole

Preparing perforated bracket

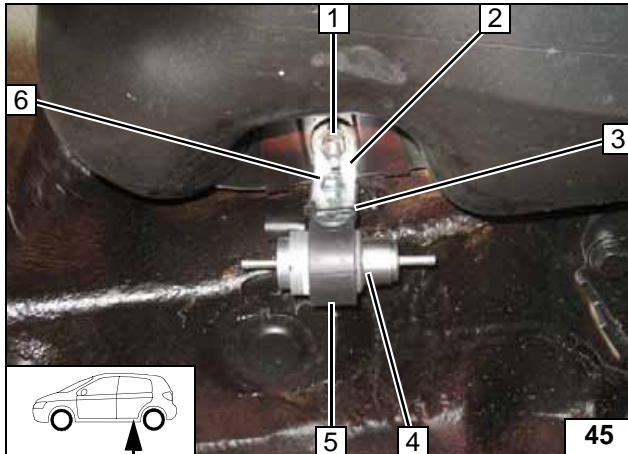

- 1 Original vehicle stud bolt
- 2 Perforated bracket
- 3 Cable tie
- 4 Metering pump
- 5 Metering pump mounting
- 6 M6x25 bolt, flanged nut



**Installing metering pump**

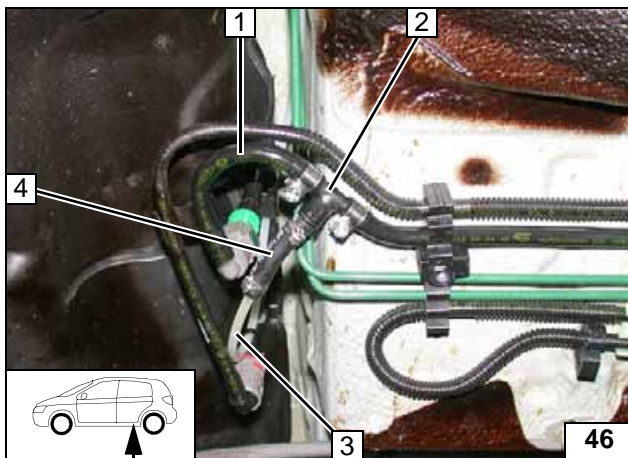

Cut off fuel supply line 1 as shown.

- 2 8x5x8 fuel standpipe; 10mm dia. clamp [2x]
- 3 Fuel line
- 4 Hose section, 10 mm dia. clamp [2x]



**Fuel stand-pipe**

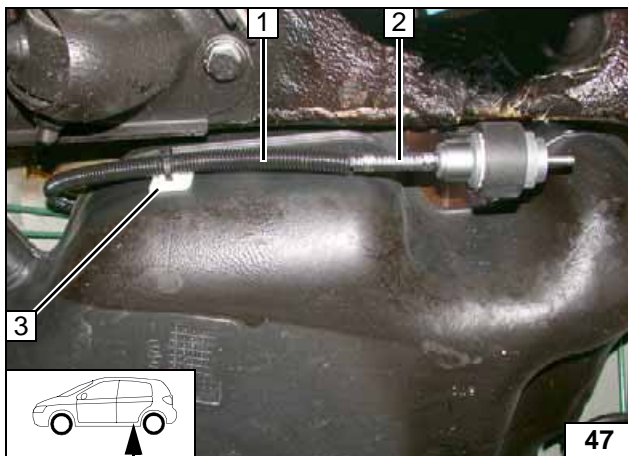

- 1 Fuel line in corrugated tube
- 2 Hose section, 10 mm dia. clamp [2x]
- 3 Remove adhesive surface, adhesive base, cable tie



**Connect-ing meter-ing pump**

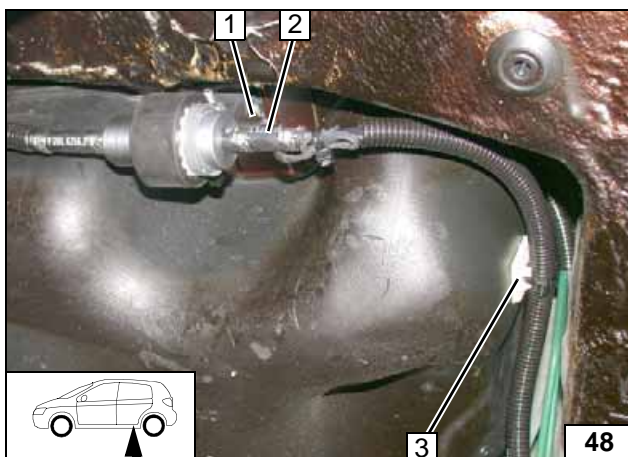

Check the position of the components; adjust if necessary. Check that they have freedom of movement.

- 1 Wiring harness of metering pump, connector installed
- 2 Hose section, 10 mm dia. clamp [2x]
- 3 Remove adhesive surface, adhesive base, cable tie



**Connect-ing meter-ing pump**

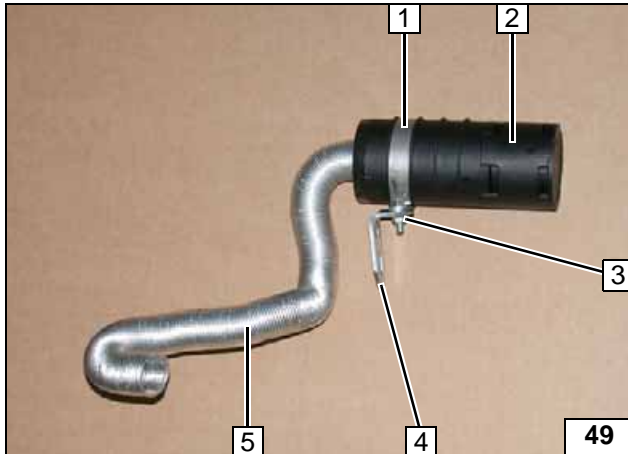
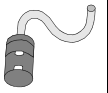

**Combustion air**

- 1 51mm dia. clamp
- 2 Silencer
- 3 M5x16 bolt, washer, flanged nut
- 4 Angle bracket
- 5 Mould combustion air pipe

**Premounting silencer**

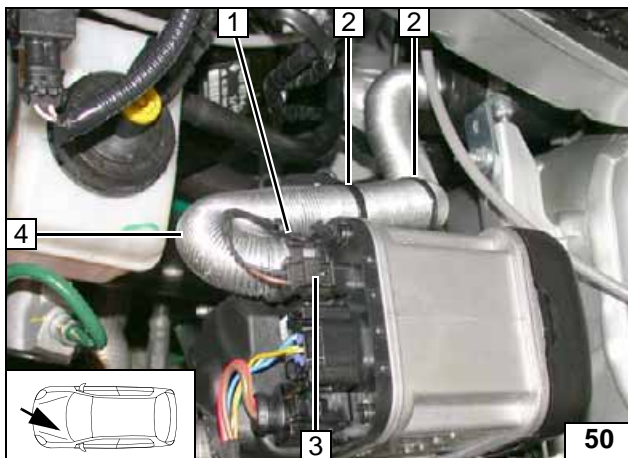

- 1 25mm dia. clamp
- 2 Cable tie
- 3 Wiring harness of circulating pump mounted
- 4 Combustion air pipe

**Installing combustion air pipe**

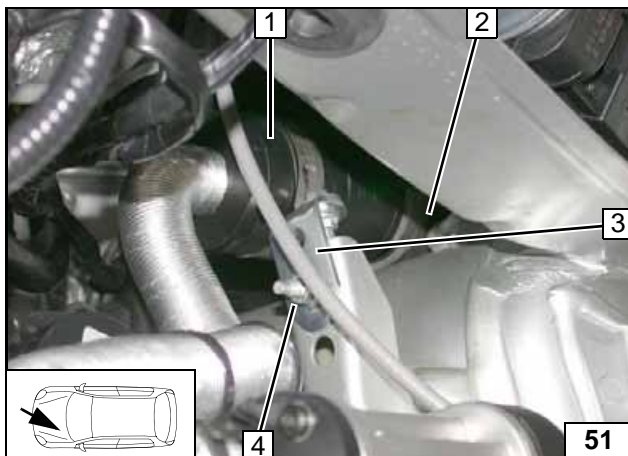

Paste insulation strip 2 as flap protection on silencer 1.

- 3 Angle bracket
- 4 M6x20 bolt, flanged nut, existing hole



**Installing silencer**





**Coolant circuit**

**WARNING!**

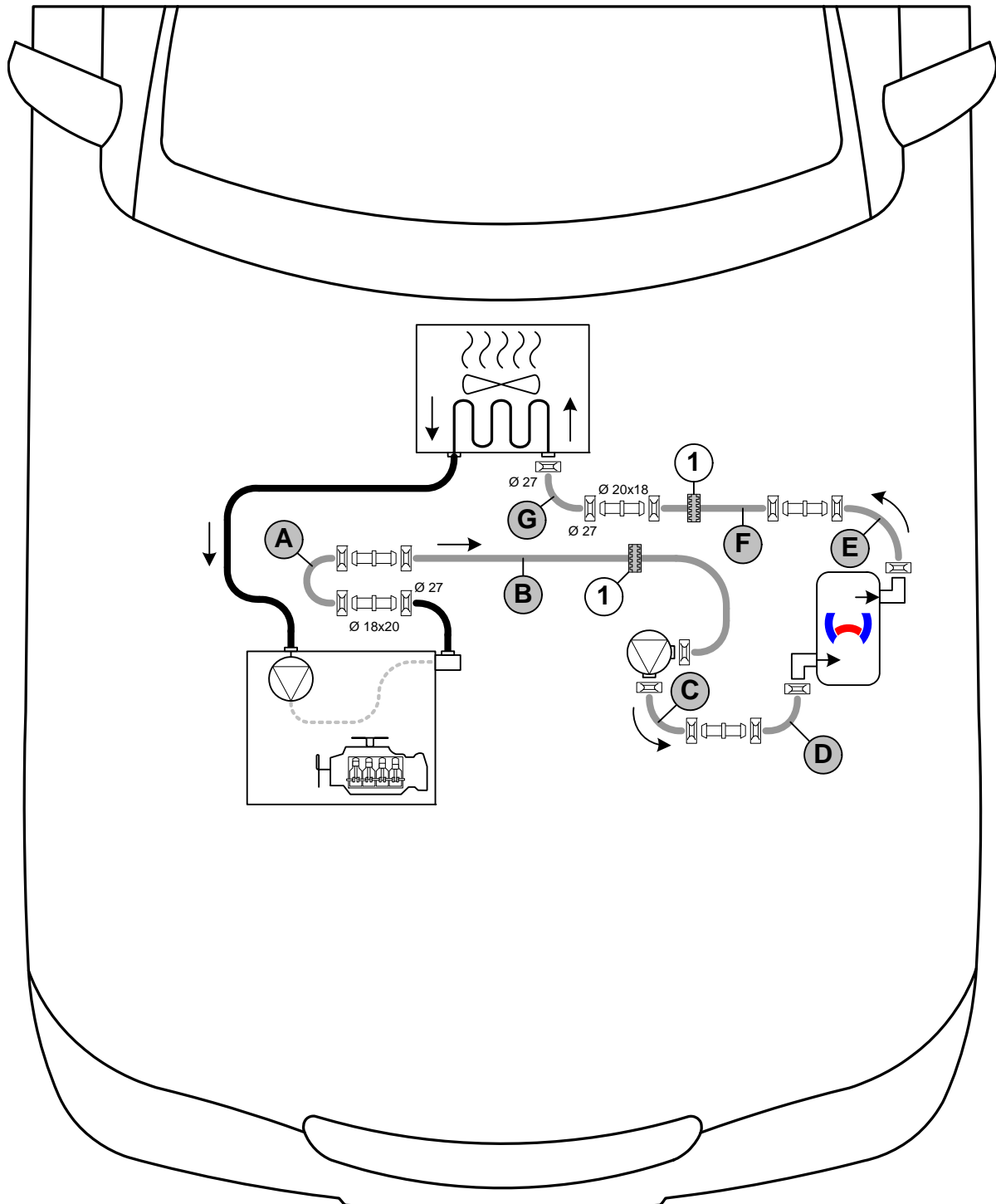
Any coolant running off should be collected in an appropriate container. Install coolant hoses kink-free. Unless specified otherwise, always fasten using cable ties. Position clamps so that other hoses cannot be damaged. The heater must be filled with coolant when installing the hoses. The connection should be "inline" based on the following diagram:



Hose routing diagram

All spring clips without a specific designation  = 25mm dia.  
 1 = Black (sw) rubber isolator  [2x].  
 All connecting pipes without specific designation  = 18x18mm dia.





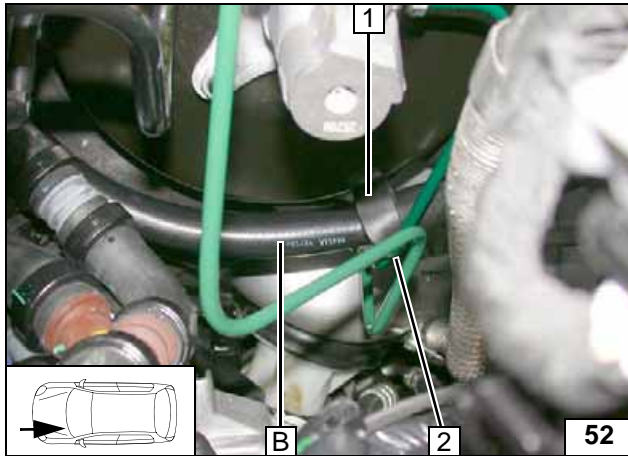
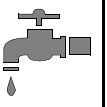

Route hose **B** to cutting point. Align black (sw) rubber isolator **1** and fasten with cable tie **2** to the original vehicle line.



**Routing in engine compartment**

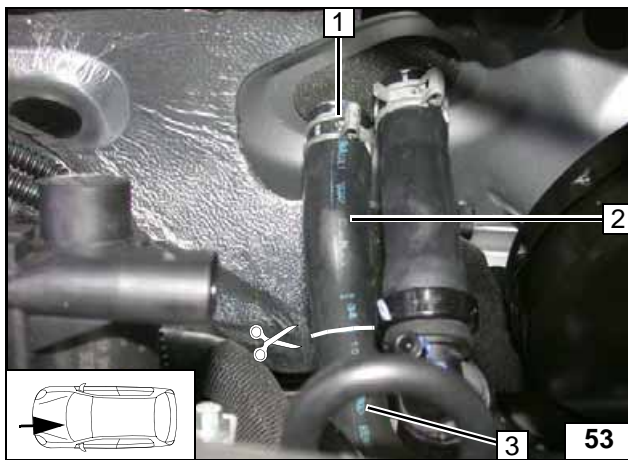

Cut hose of engine outlet / heat exchanger inlet **3** at the marking.

- 1** Remove and discard spring clip
- 2** Remove and discard hose section of heat exchanger inlet.



**Cutting point**

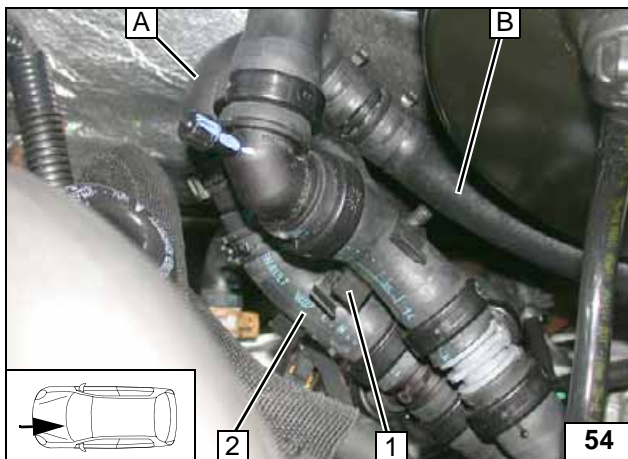

- 1** Install hose bracket
- 2** Hose on engine outlet

**Connecting engine outlet**

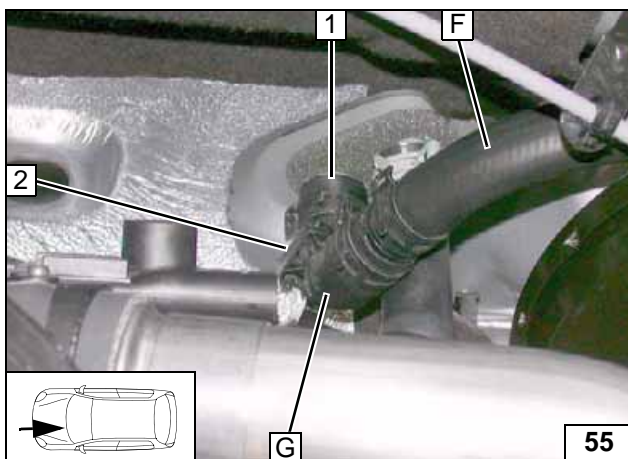

- 1** Connection piece of heat exchanger inlet
- 2** Install hose bracket

**Connecting heat exchanger inlet**



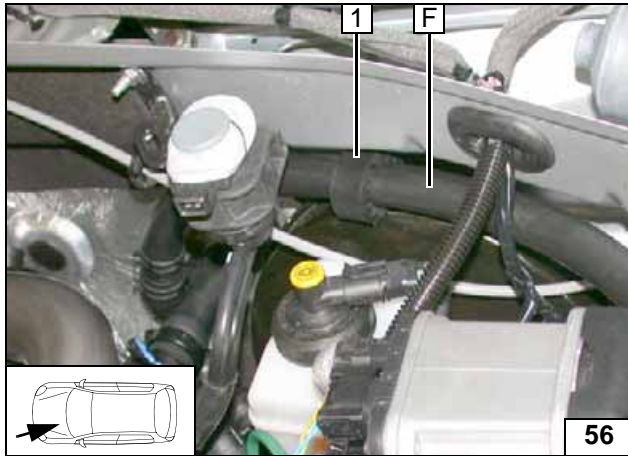

Slide black (sw) rubber isolator 1 on to hose F and align.



Routing in engine compartment

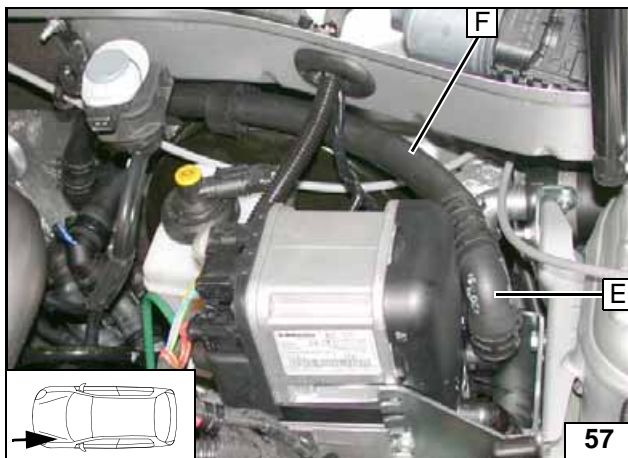

Aligning hoses. Ensure sufficient distance from neighbouring components.



Connecting heater outlet

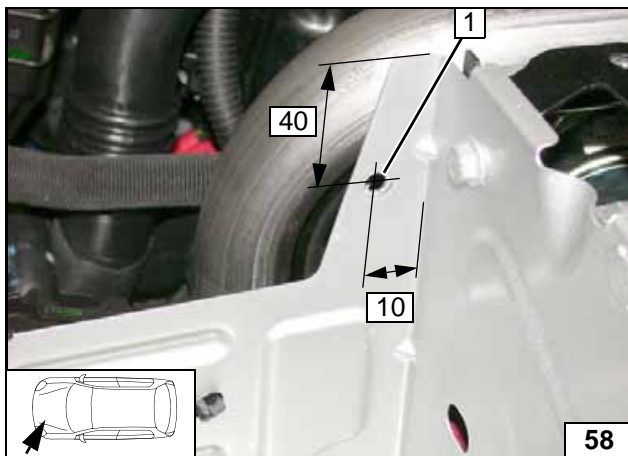

**Expansion tank**

1 7mm dia. hole

Hole in battery carrier

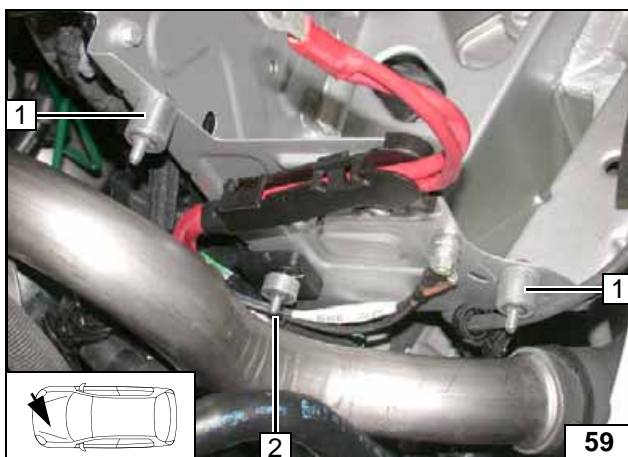

- 1 M6x30 bolt, large diameter washer, 20mm shim, pin lock [2x each]
- 2 M6x30 bolt, large diameter washer, 10mm shim, pin lock

Installing bolt

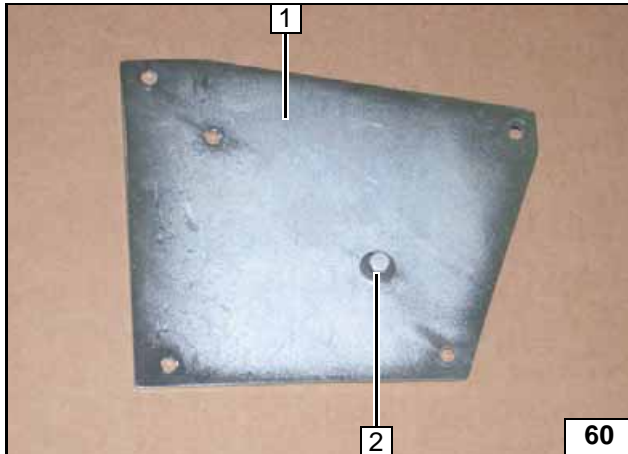
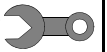

- 1 Bracket of expansion tank
- 2 Premount M6x16 bolt, large diameter washer, flanged nut loosely

Premounting bolt

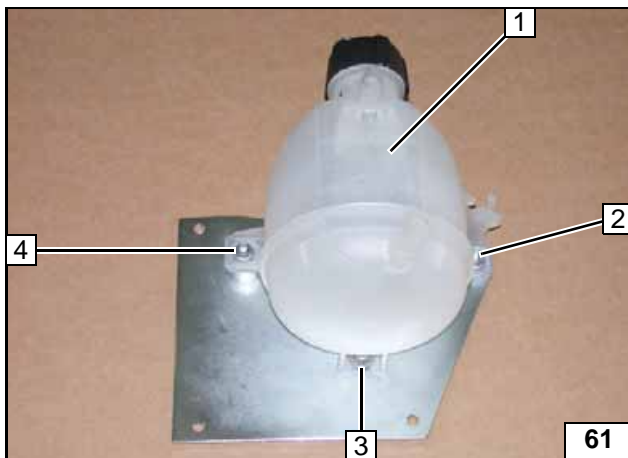

- 1 Expansion tank
- 2 M6x20 bolt, flanged nut
- 3 Tighten bolt
- 4 M6x25 bolt, 15mm shim, flanged nut

Premounting expansion tank

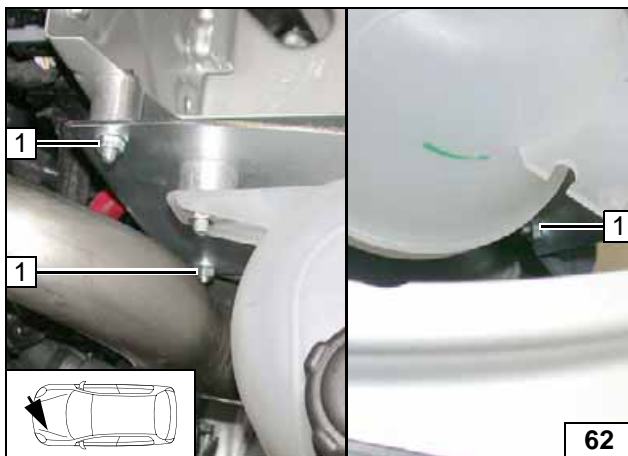

- 1 M6 Flanged nut [3x]

Installing expansion tank

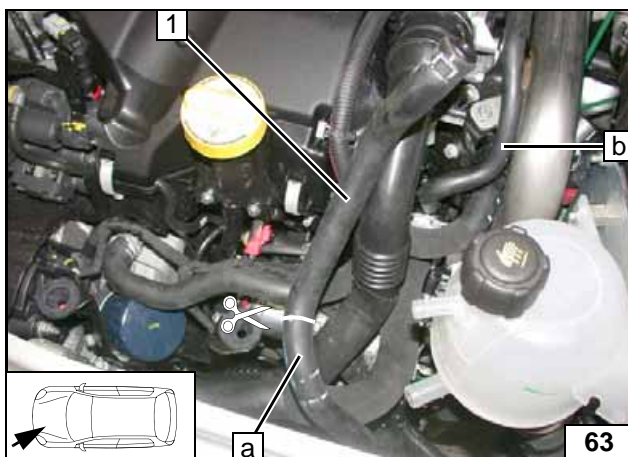

Cut off hose of supply line to expansion tank **a** at the marking. Remove hose of expansion tank supply line **b**. Spring clips will be reused.

- 1 Discard section



Cutting out hose

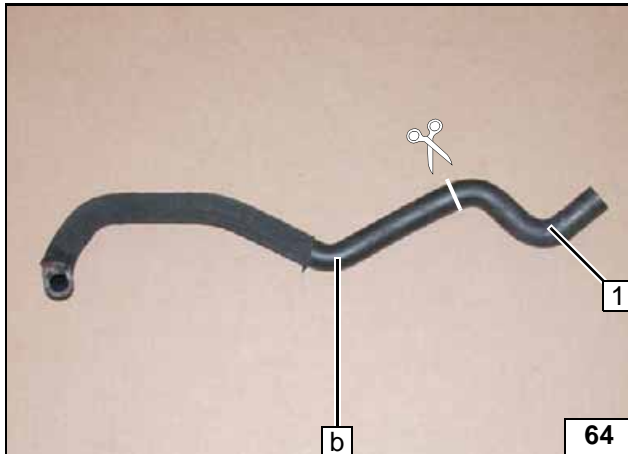
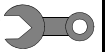

- 1 Discard section
- b Hose of expansion tank supply line

Cutting out hose

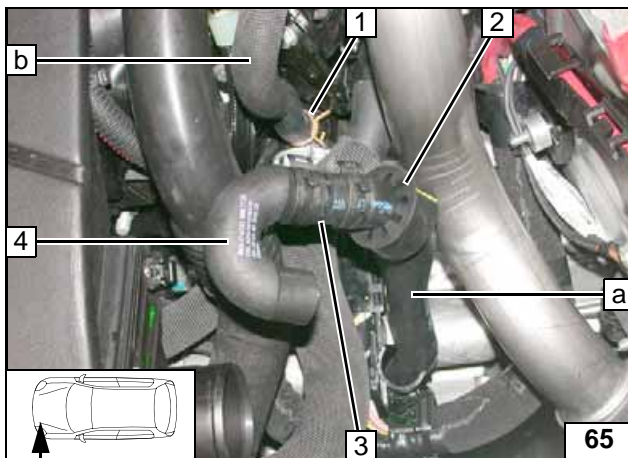

Expansion tank removed for better display. Install hose of expansion tank supply line **b** as shown. Slide black (sw) rubber isolator **2** on to hose of expansion tank supply line **a**.



- 1 Original vehicle spring clip
- 3 18x18mm connecting pipe, 25mm dia. spring clip [2x]
- 4 180°, 18mm dia. moulded hose

Cutting out hose

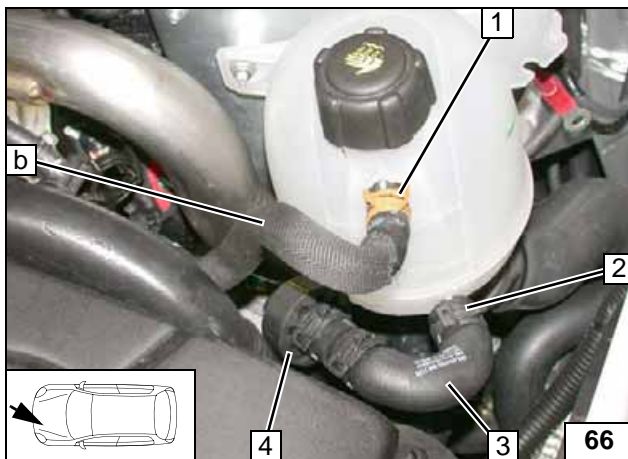

- 1 Original vehicle spring clip
- 2 25mm dia. spring clip
- 3 180° moulded hose
- 4 Position black (sw) rubber isolator

Connect-  
ing expan-  
sion tank

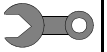

## Final Work

### WARNING!

Reassemble the disassembled components in reverse order. Check all hoses, clamps and all electrical connections for firm seating. Insulate all loose wires and tie back.

Only use manufacturer-approved coolant. Spray heater components with anti-corrosion wax (Tectyl 100K, Order No. 111329).

- Connect the battery.
- Fill and bleed the coolant circuit according to the vehicle manufacturer's specifications.
- Adjust digital timer, teach Teleststart transmitter
- Make settings on A/C control panel according to the "Operating Instructions for End Customer".
- Place signboard "Switch off parking heater before refuelling" in the area of the filler neck.
- For initial start-up and function checks, please see installation instructions

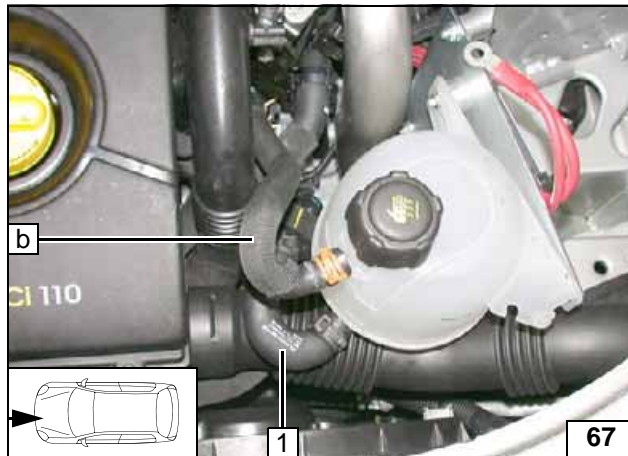

Ensure sufficient distance from neighbouring components.

**1** 180° moulded hose

**b** Hose of expansion tank supply line



**Aligning hoses**

**Webasto**  
*Feel the drive*

Webasto AG  
 Postfach 80  
 D-82132 Stockdorf / Germany  
 National Hotline: 01805 93 22 78  
 (14 Cent aus dem deutschen Festnetz)  
 Hotfax: 0395 5592 353  
 Hotmail: technikcenter@webasto.com  
 http://www.webasto.com

## Operating Instructions for End Customer

Please remove page and add to the vehicle operating instructions.

**Note:**

We recommend matching the heating time to the driving time.

Heating time = driving time

**Example:**

For a driving time of approx. 20 min. (in one direction), we recommend not exceeding a switch-on time of 20 min.

In vehicles with passenger compartment monitoring it is to be deactivated in addition to defining the vehicle settings for the heating operation.

Instructions on deactivation can be taken from the operating instructions of the vehicle.

Before parking the vehicle, make the following settings:

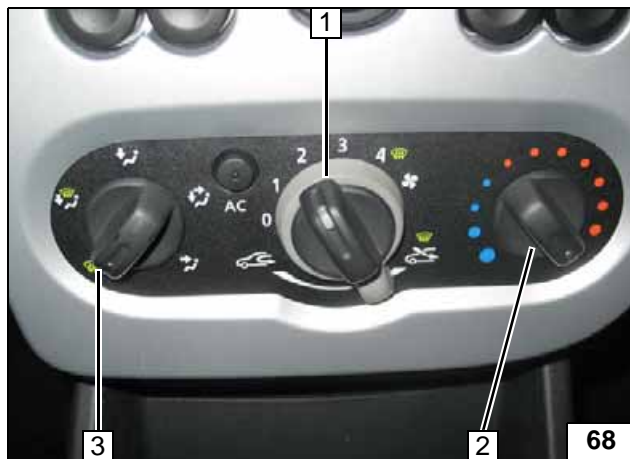

- 1 Set fan to level "1", or possibly "2"
- 2 Set temperature to "max."
- 3 Direct air outlet toward windscreen

Manual air conditioning