



Montaažiskeem / Mounting Instructions / Монтажная схема

Dacia Duster 2010-

Art. 803060
Art. 803064

Astmelauad Ø 42

Sideboard steps Ø 42

Пороги с пластиной Ø 42



- | | |
|---|-----|
| 1. Astmelaud / sideboard step / пороги с пластиной | 1+1 |
| 2. Plaat / bracket / кронштейн | 1+1 |
| 3. Kronstein / bracket / кронштейн | 1+1 |
| 4. Kronstein / bracket / кронштейн | 1+1 |
| 5. Kronstein / bracket / кронштейн | 1+1 |
| 6. T-Polt / T-bolt / Т-болт | 4 |
| 7. Polt / bolt / болт M8x30 mm | 4 |
| 8. Polt / bolt / болт M10x30 mm Wülock | 8 |
| 9. Mutter / nut / гайка M8 DN 985 | 4 |
| 10. Mutter / nut / гайка M10 DN 934 | 4 |
| 11. Mutter / nut / гайка M10 DN 985 | 8 |
| 12. Seib / washer / шайба 8,4x16x1,6 mm | 4 |
| 13. Seib / washer / шайба 8,4x24x2 mm | 4 |
| 14. Seib / washer / шайба 10,5x30x2,5 mm | 12 |
| 15. Vedruseib / spring washer / пружинная шайба A10 | 4 |
| 16. Tõmbeneet / blind rivet / заклепка 4x6 mm | 16 |
| 17. Tõmbeneet / blind rivet / заклепка 4x8 mm | 18 |

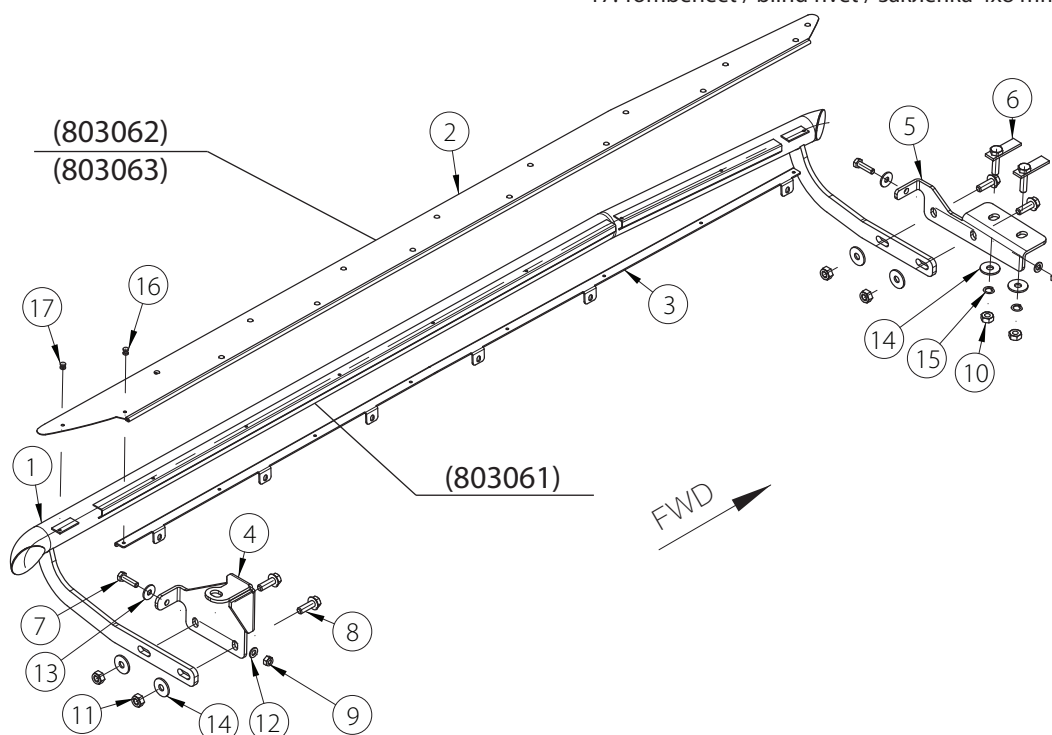

Vajalikud tööriistad / Required Tools / Необходимые инструменты

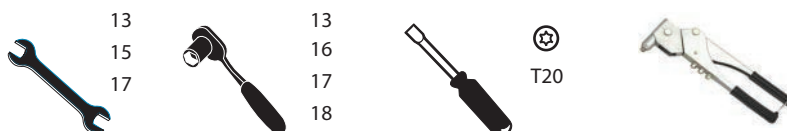

Dacia Duster 2010-

Art. 803060
Art. 803064

Astmelauad Ø 42

Sideboard steps Ø 42

Пороги с пластиной Ø 42

Paigaldamine / Instructions / Инструкция установки

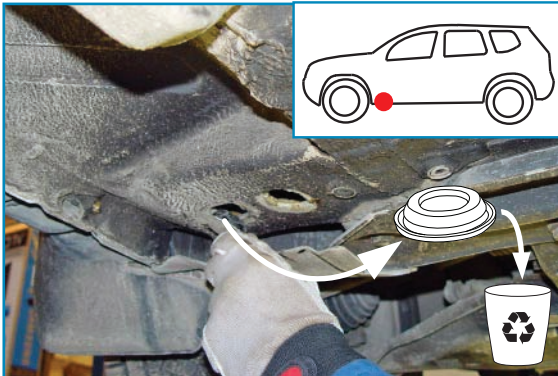

Pilt 1 / Pic. 1 / Рис. 1

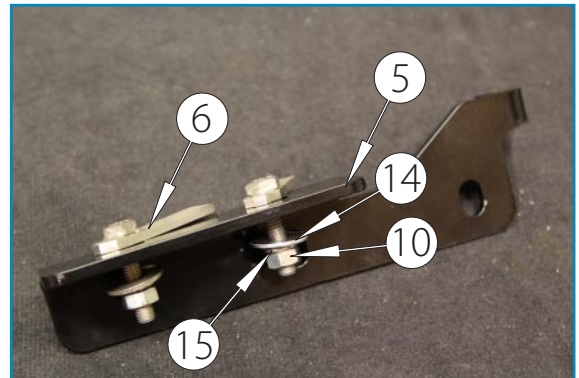

Pilt 2 / Pic. 2 / Рис. 2



Pilt 3 / Pic. 3 / Рис. 3

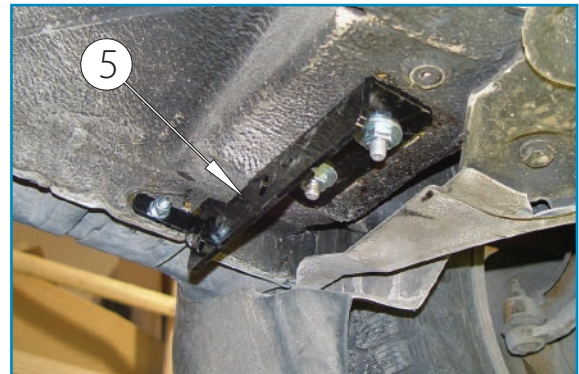

Pilt 4 / Pic. 4 / Рис. 4

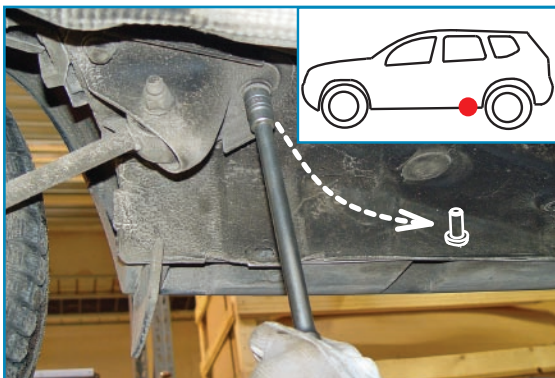

Pilt 5 / Pic. 5 / Рис. 5

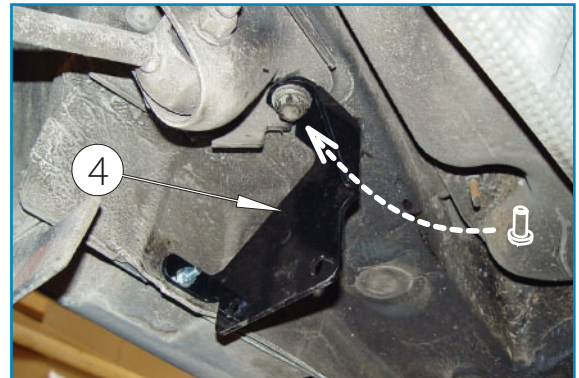

Pilt 6 / Pic. 6 / Рис. 6

Dacia Duster 2010-

Art. 803060
Art. 803064

Astmelauad Ø 42

Sideboard steps Ø 42

Пороги с пластиной Ø 42

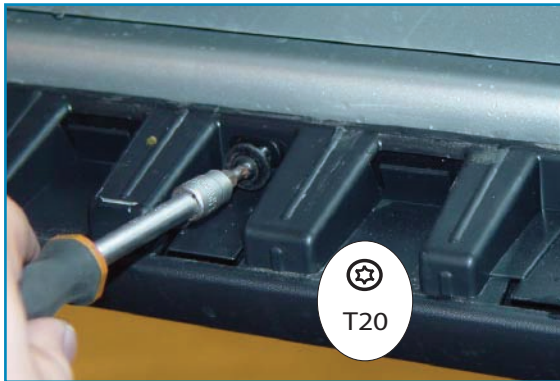

Pilt 7 / Pic. 7 / Рис. 7

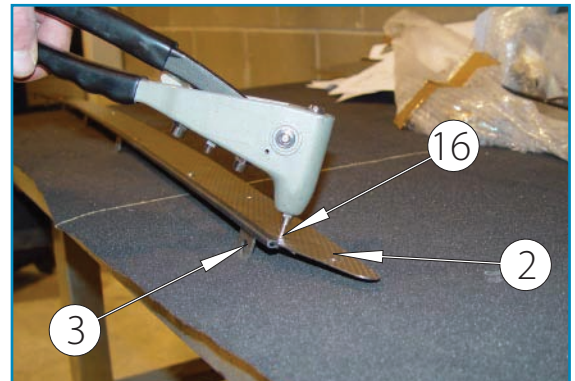

Pilt 8 / Pic. 8 / Рис. 8



Pilt 9 / Pic. 9 / Рис. 9



Pilt 10 / Pic. 10 / Рис. 10



Pilt 11 / Pic. 11 / Рис. 11

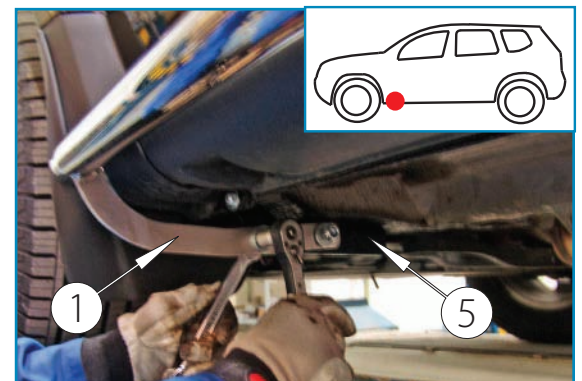

Pilt 12 / Pic. 12 / Рис. 12

Dacia Duster 2010-

Art. 803060
Art. 803064

Astmelauad Ø 42

Sideboard steps Ø 42

Пороги с пластиной Ø 42

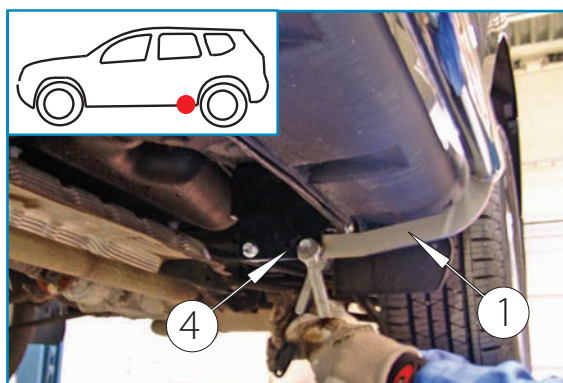

Pilt 13 / Pic. 13 / Рис. 13



Pilt 14 / Pic. 14 / Рис. 14

Toote andmed / Data of the product / Данные о товаре

- Mõõdud / Measures / Размеры: 130x360x1760 mm.
- Kaal / Weight / Масса: 13,8 kg.
- Paigaldusaeg / Time of mounting / Время установки: 60 min.
- Tähtsad markeeringud / Important labels / Важные этикетки:



1. Komplekteerija number. / The number of the assembler / Номер комплектовщика
2. Tooteinfo pakendil / Product information on the package / Информация на упаковке
3. Tooteinfo tootel / Product information on the product / Информация на товаре
4. Kvaliteedi kontrolli tähis / Quality control number / Знак контроля качества